



# PRESENTATION

## TUBE LIFTER

### FOR CHEESE FORMS

MANIBO tube lifters are available in various configurations and types of grips. All the tube lifters boast a particular feature: their innovative and simple possibility of being assembled according to handling needs, guarantees that the customer receives exactly the right lifter for their needs.

## Specifications



The lifting system of tubes has been designed for rapid and precise handling of medium-small loads. It consists of a plastic tube, reinforced by a steel spiral, at the end of which is the suction cup suitable for gripping the part to be handled. The vacuum generated by the turbine allows both the grip of the form, through the suction cup, and its weight balance, thanks to the contraction of the lifting tube.



## ABOUT US

MANIBO S.r.l. holds a consolidated position in the field of industrial manipulation and is now a reference partner for numerous leading companies not only in Italy but throughout the world. MANIBO takes particular care in solving handling problems in companies in the food, pharmaceutical, and ATEX environments. We guarantee timely responses and rapid decisions.

## WHY CHOOSE US

-  Our professionals boast experience, professionalism and precision.
-  Particular attention in the testing phase with strict tests for uses even in ATEX environments.
-  Accurate design phase to adapt your manipulator to your machine and your environment.

## Safety devices

- » The system, even in the event of a power failure, holds the lifted load, so it can descend down to the ground, in an easily controllable manner, without risk to the operator.
- » Objects weighing more than the maximum capacity cannot be lifted.



## Accessories

We offer consumers different standardized accessories that allow the creation of customized solutions for the most diverse needs. Our systems are completely modular, so you can integrate them at any time



**CONTACT US FOR A QUOTE**

## AG033 - TUBULAR ARM WITH TIE ROD

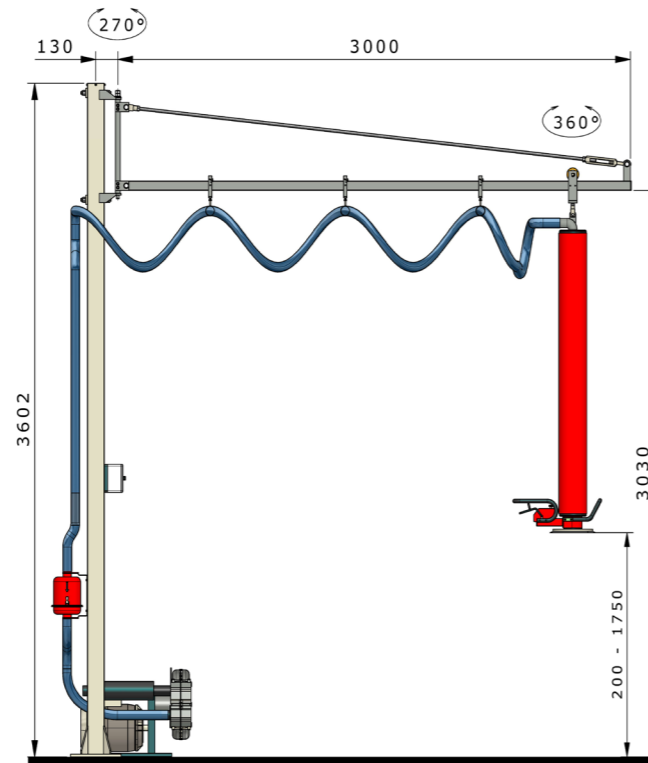
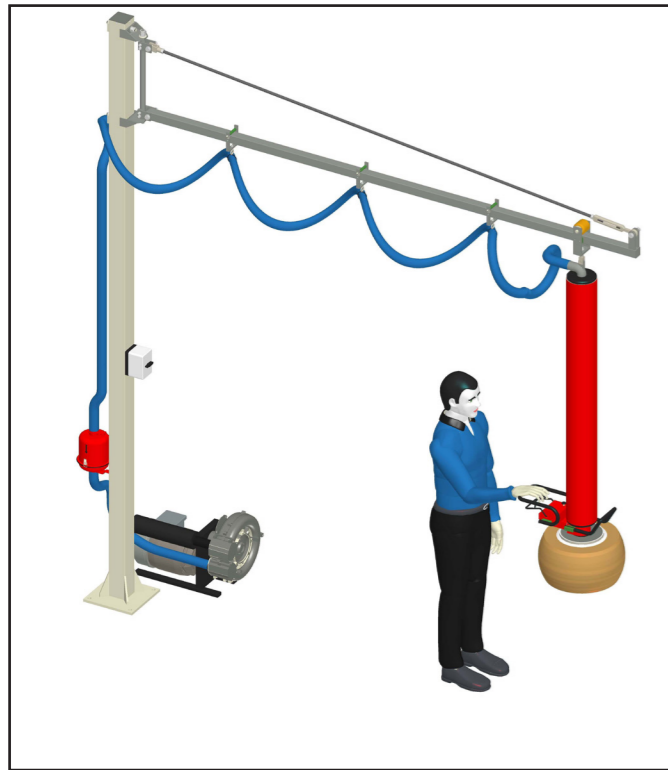

## AG044 - ALUMINUM ARM WITH TIE ROD

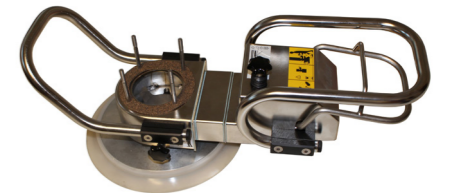
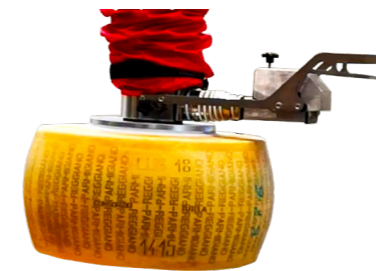
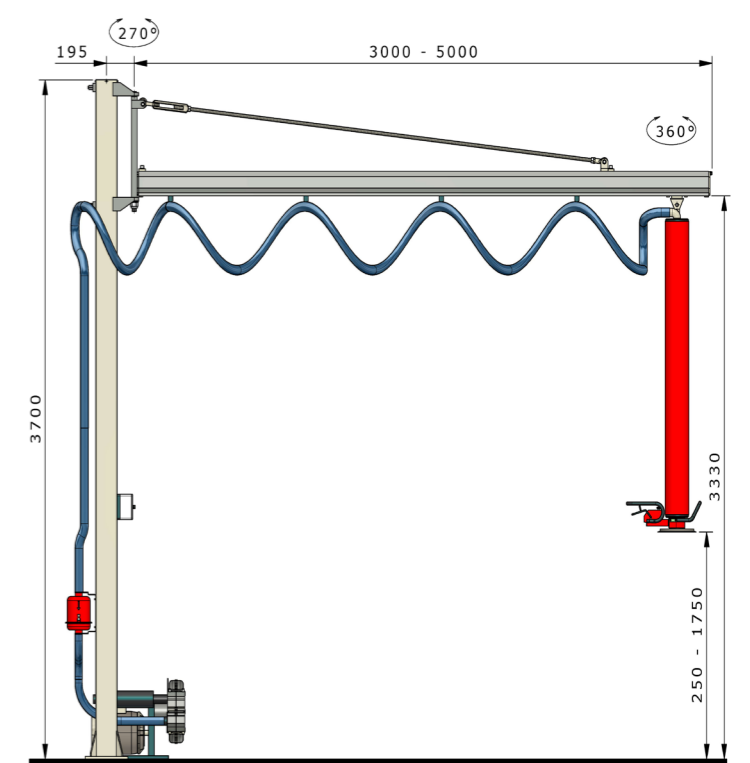
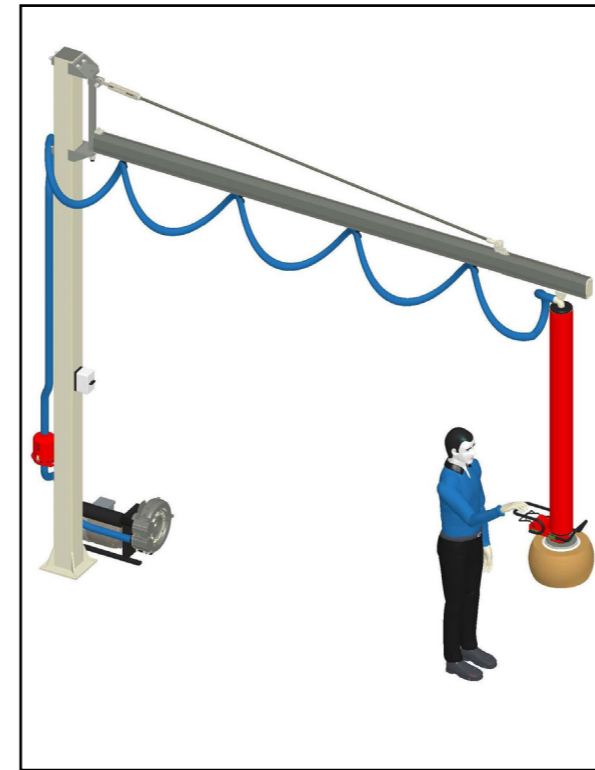

### Features

- Very light, recommended for fast and frequent operations
- Maximum radius of action 3000 mm,
- Arm weight 17 kg,
- 270° rotation
- Maximum net capacity 50 kg,
- Column height according to the lifting heights
- Base plate 300 x 300 mm
- Lifting trolley for sliding on bearings,
- Sliding cable trolleys on rollers

### Features

- Light and technically refined,
- Arm weight 48 kg (3), 52 kg (4) and 56 kg (5m),
- 270° rotation,
- Maximum net capacity 100 kg (50 kg per arm 5 m),
- Column height according to lifting heights
- Lifter trolley sliding on wheels, with bearings inside the profile,
- Sliding cable trolleys on plastic wheels inside the profile.



## AG055 - OVERHANGING ALUMINUM ARM

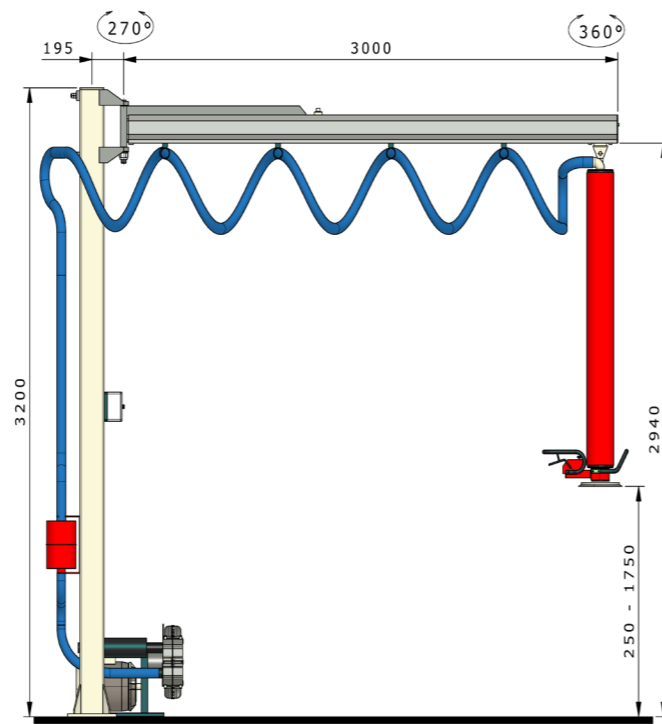
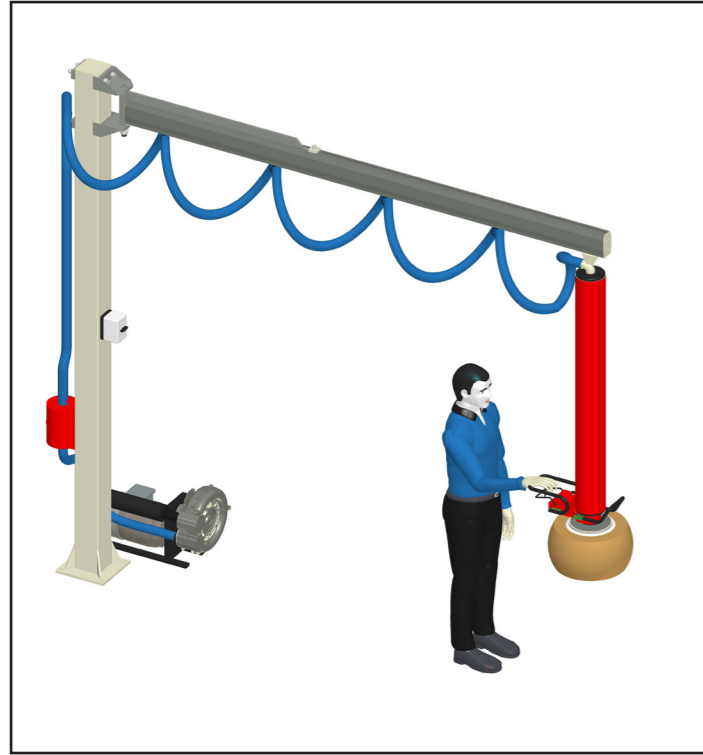

## AG057 - ARTICULATED TUBULAR ARM

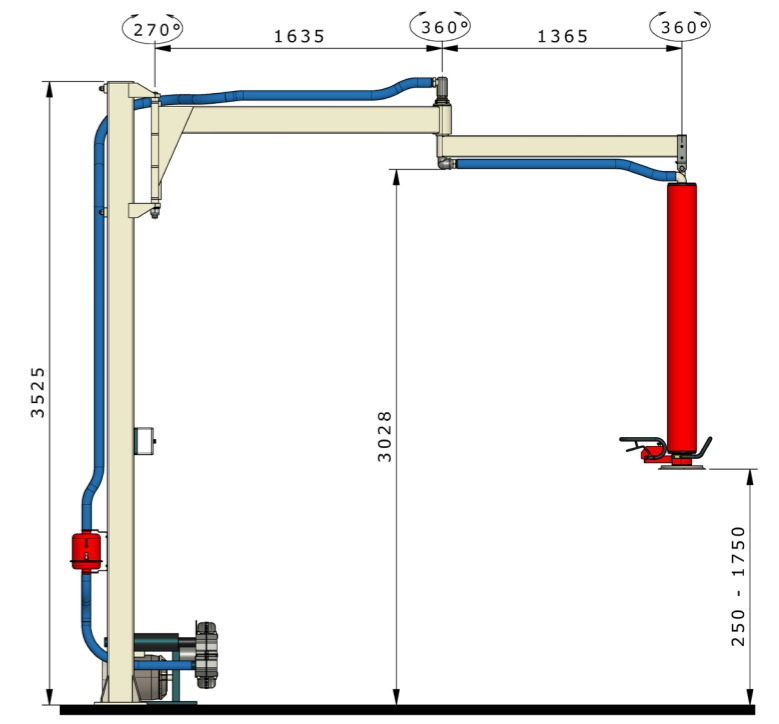
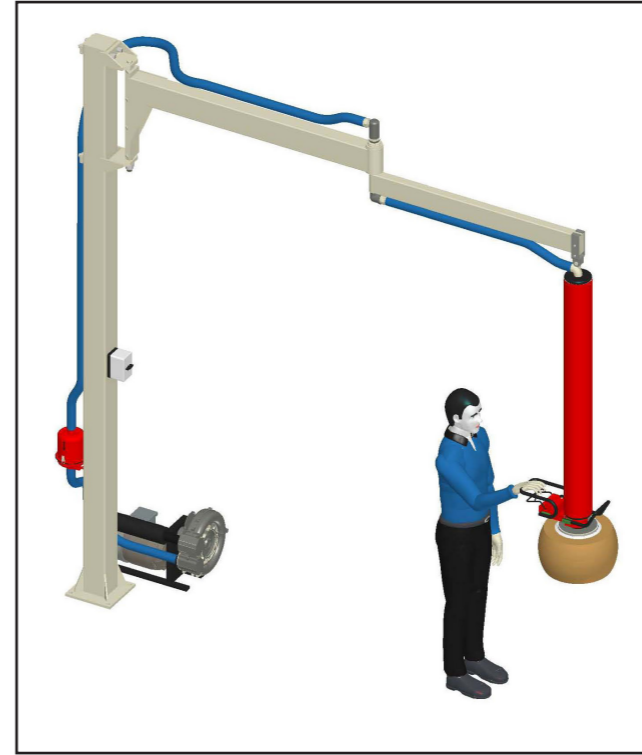

### Features

- Lightweight, quiet and compact, suitable for use in lower environments,
- The maximum radius of action 3000 mm,
- Arm weight 32 kg,
- 270 ° rotation,
- Maximum net capacity 50 kg,
- Column height according to lifting heights,
- Base plate dimension 300 x 300 mm,
- Lifter trolley sliding on wheels with bearings inside the profile.
- Sliding cable trolleys on plastic wheels inside the profile

### Features

- Small footprint in height, indispensable in the presence of vertical obstacles to avoid,
- Maximum range of action 4000 mm,
- Arm weight 74 kg (3) 79 kg (3.5) 84 kg (4 m),
- Rotation around column 270 °,
- Continuous 360 ° articulation rotation, thanks to a rotating swivel with internal air passage,
- Maximum net capacity 100 kg,
- Column height according to the lifting heights





# MAIN PARTS OF THE MACHINE

**Air filter**

Allows you to preserve the integrity of the lifter longer. Absolutely necessary in very dusty environments.

**Aluminum arm**

Available lengths 3, 4 and 5 m.

**Protective sock**

Protects the lifting tube from external wear.

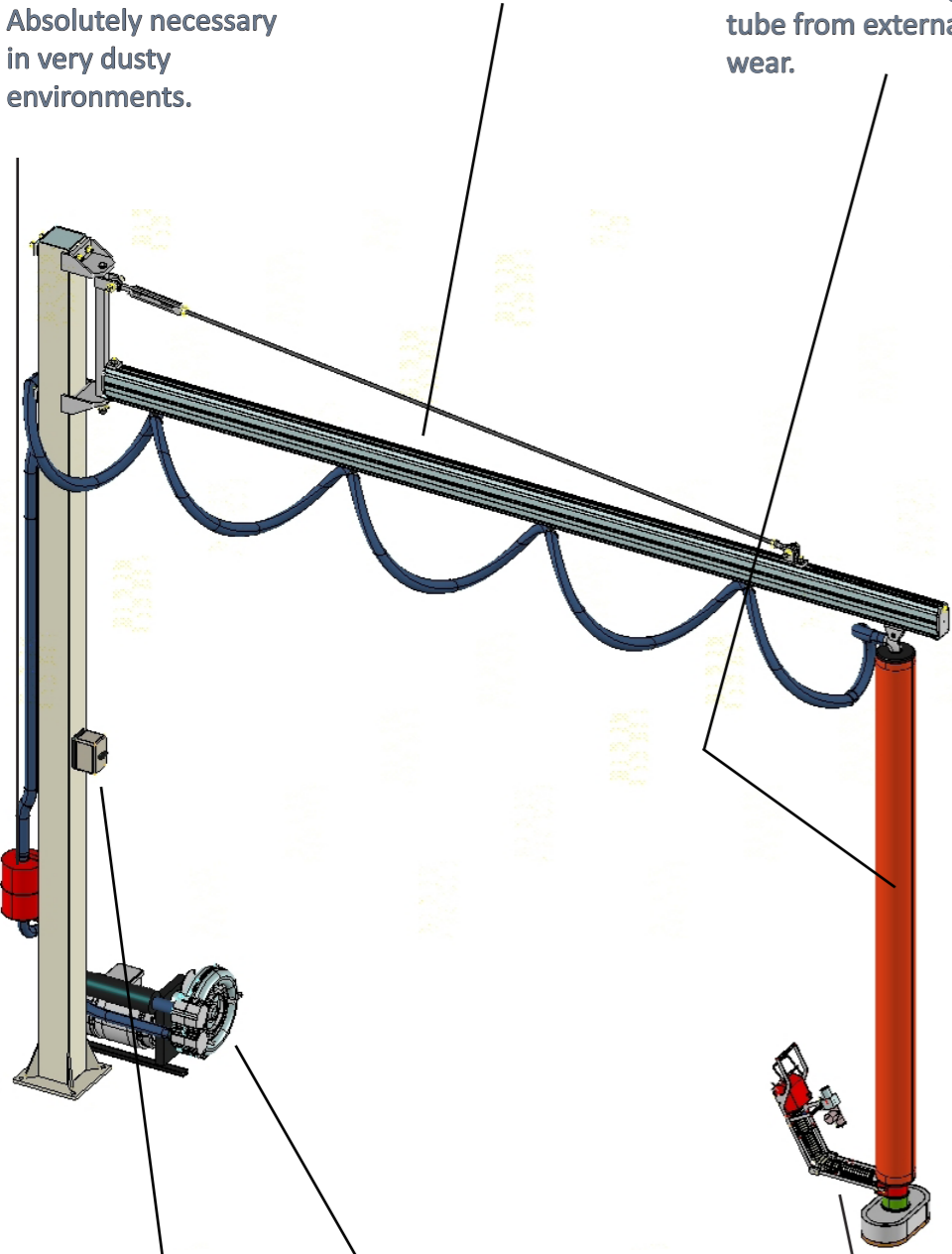

**Electric pump for vacuum generation**

On request it is also possible to provide a soundproofing box to reduce the sound level produced by the pump during use.

**Ergonomic handle with rotating attachment**

Lifting tubes do not lift loads heavier than their capacity.





# Accessories

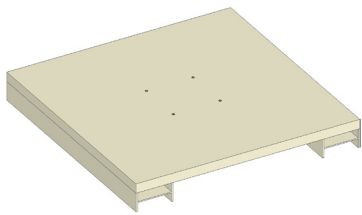

**SELF-SUPPORTABLE INFORABLE BASEMENT**  
Dimensions 1200 X 1200 X 160 mm.  
Suitable to be transported both with a pallet truck and a forklift.

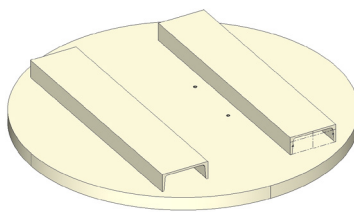

**ROUND SELF-SUPPORTING INFORABLE BASEMENT**  
Suitable to be transported by forklift.  
Diameter 1330 mm. Suitable for 3 m outreach crane.

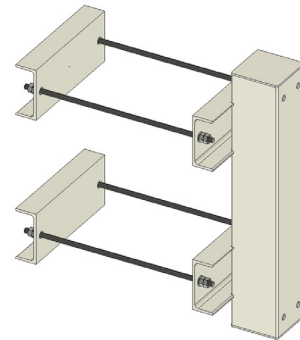

**SHELF FOR ANCHORAGE ON COLUMN**  
Column fixing element.



**ROTATING SWIVEL 360°**  
Allows to orient the load by rotating it with respect to the handle.



**ANGULAR JOINT**  
It allows the load to rotate with respect to the handle.

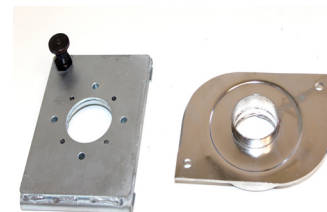

**QUICK CHANGE**  
Device used when replacing the lifting suction cup with a different tool.



**EXTENDED RIGID HANDLE**  
It allows you to move large loads while remaining out of their space.



**EXTENDED FLEXIBLE HANDLE**  
It allows you to move loads to elevated heights in ergonomics.



**SOUNDPROOF BOX**  
It can be supplied for all types of vacuum electric generator. Reduces the noise level of the pump.



Via del Lavoro 85, 40033  
Casalecchio di Reno BO



+39 051 6468143



[www.manibo.eu](http://www.manibo.eu)  
[manibo@mani-bo.com](mailto:manibo@mani-bo.com)